

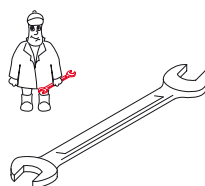

Gebr. Becker GmbH
Hölker Feld 29-31
D-42279 Wuppertal

Wartung
Maintenance
Entretien
Manutenzione
Mantenimiento



	Pos.	Menge ²⁾ Quantity Quantité Quantità Cantidad	Bestell-Nr. Ident No. No. Identification No. Identificazione No. de pedido	Bezeichnung Description Designation Designazione Descripción
KVT 3.80	...	1	549000 21100	Dichtungssatz, Complete set of seals, Jeu de joints, Kit di guarnizioni, Junta completa
	11	SATZ (KIT)	901330 00004	Schieber, Rotor Vane, Palette, Empujador
	11	SATZ (KIT)	901379 00004	" (KVT 3.80/6)
	68	1	909507 00000	Filterpatrone, Filter cartridge, Cartouche Filtrante, Cartuccia filtro, Cartucho de filtro
	68	1	909587 00000	" (KVT 3.80/6) - Polyester
91	1	909510 00000	Filterpatrone, Filter cartridge, Cartouche Filtrante, Cartuccia filtro, Cartucho de filtro	

²⁾ erforderlich / necessary / nécessaire / necessaria / necesaria



Ersatzteilliste
Spare parts list
Liste de pièces de rechange
Listino pezzi di ricambio
Lista de piezas de recambio
Lista de peças sobresselentes
Reserveonderdelenlijst
Reservedelsliste
Reservdelslista

Reservedelsliste
Varaosaluettelo
Wykaz części zamiennych
Seznam náhradních dílů
Tartalékalkatrész lista
Κατάλογος ανταλλακτικών
Перечень запасных частей
备用零件目录
スペアパーツリスト

KVT 3.80



28000021102 04/2010

Index-C

<p>SERVICE</p>	<p>D-42279 Wuppertal www.becker-international.com</p>	No. C year <input type="text" value="XXXX"/>	Index Option <input type="radio"/> Germany
	CE	type KVT 3.80-XX	
	frequency	<input type="text" value="XXXX"/> Hz	
	speed	<input type="text" value="XXXX"/> min ⁻¹	
	power required	<input type="text" value="XXXX"/> kW	
	inlet capacity	<input type="text" value="XXXX"/> m ³ /h	
max. vacuum	<input type="text" value="XXXX"/> mbar		

D Service:
Tel: +49 (0)202 697-171
Fax: +49 (0)202 64 44 74
E-Mail: info@becker-international.com
www.becker-international.com



KVT 3.80

Pos.	Bestell Nr.	Beschreibung	
...	549000 21100	DICHTUNGSSATZ ¹⁾	
6	000100 21100	GEHÄUSE	
9	020004 21100	KOLBEN	
11	901330 00004	SCHIEBER (SATZ) ²⁾	
15	000801 21100	SEITENDECKEL	
16	000701 21100	SEITENDECKEL	
18	001100 21100	LAGERDECKEL, A-SEITE	
19	001000 21100	LAGERDECKEL, B-SEITE	
20	025511 21100	DICHTUNG	
24	911312 00000	DICHTUNGSSCHLAUCH	
26	917152 00000	AUSGLEICHSCHLEIBE	
27	906540 00000	WELLENDICHRING	
28	906612 50000	WÄLZLAGER 3205 2RS C3 TA	
29	906657 00000	WÄLZLAGER NU 205/ZS	
31	511400 10100	SATZ DISTANZSCHEIBEN	
37	945217 00000	SECHSKANTSCHRAUBE	
38	016801 21100	SPANNSCHLEIBE	
39	949807 00000	SENKSCHEIBE	
41	945224 00000	SECHSKANTSCHRAUBE	
42	945222 00000	SECHSKANTSCHRAUBE	
45	948742 00000	PASSKERBSTIFT	
47	947736 00000	PASSFEDER	
50	053201 21100	LATERNE	
52	950308 00000	UNTERLEGSCHLEIBE	
53	945337 00000	INNENSECHSKANTSCHRAUBE	
57	949409 00000	UNTERLEGSCHLEIBE	
58	945270 00000	WELLENENDSCHRAUBE	
61	040101 21100	FILTERGEHÄUSE	
62	025501 21100	DICHTUNG	
64	946955 00000	STIFTSCHRAUBE	
65	951003 00000	STIFTSCHRAUBE	
67	964407 00000	SCHALLDÄMPFERROHR	
68	909507 00000	FILTERPATRONE C 1112/2 (1x) ²⁾	
71	009000 27000	ANPRESSFEDER	
73	040201 21100	FILTER-DECKEL	
75	025518 21100	DICHTUNG	
76	025516 21100	DICHTUNG	
77	022802 21100	FILTERTRÄGER	
79	945320 00000	INNENSECHSKANTSCHRAUBE	
81	947504 00000	UNTERLEGSCHLEIBE	
83	952019 00000	SPANNHÜLSE	
91	909510 00000	FILTERPATRONE C 713 (1x) ²⁾	
93	946965 00000	STIFTSCHRAUBE	
94	947105 00000	SECHSKANTMUTTER	
95	949450 00000	U-SCHLEIBE	
97	950304 00000	U-SCHLEIBE	
98	945322 00000	INNENSECHSKANTSCHRAUBE	
103	068801 21100	DECKEL	
104	025513 21100	DICHTUNG	
105	945319 00000	INNENSECHSKANTSCHRAUBE	
106	950304 00000	U-SCHLEIBE	
110	921500 50000	HANDGRIFF	
121	560204 21100	KÜHLER	
125	025504 21100	DICHTUNG	
126	025512 21100	DICHTUNG	
127	025517 21100	DICHTUNG	
129	945372 00000	INNENSECHSKANTSCHRAUBE	
130	945328 00000	INNENSECHSKANTSCHRAUBE	
131	945320 00000	INNENSECHSKANTSCHRAUBE	
132	946930 00000	STIFTSCHRAUBE	



KVT 3.80

Pos.	Bestell Nr.	Beschreibung	
134	005602 21100	DECKEL	
142	016605 21100	ANSCHLUSS-STÜCK	
146	025507 21100	DICHTUNG	
148	945368 00000	INNENSECHSKANTSCHRAUBE	
149	741310 30000	GUMMIPUFFER	
150	950304 00000	U-SCHLEIBE	
161	918300 21100	ABDECKHAUBE	
163	920800 21100	LUFTLEITRING	
165	960700 21100	LÜFTERHAUBE	
170	945321 00000	INNENSECHSKANTSCHRAUBE	
171	945371 00000	INNENSECHSKANTSCHRAUBE	
172	945319 00000	INNENSECHSKANTSCHRAUBE	
173	949806 00000	SENKSCHEIBE	
174	951703 00000	FEDERSCHLEIBE	
175	741302 00000	GUMMIPUFFER	
176	945634 00000	GEWINDESTIFT	
178	951602 00000	RINGMUTTER	
182	014902 21100	ZWISCHENFLANSCH	
184	951916 00000	KABELTÜLLE	
185	948772 00000	ROHRNIETE	
186	947508 00000	U-SCHLEIBE	
188	945333 00000	INNENSECHSKANTSCHRAUBE	
189	950308 00000	U-SCHLEIBE	
190	951018 00000	STIFTSCHRAUBE	
191	947506 00000	U-SCHLEIBE	
192	947106 00000	SECHSKANTMUTTER	
195	902108 00000	KUPPLUNGSHÄLFTE (MOT)	
196	902209 00000	KUPPLUNGSSCHLEIBE	
197	544501 21100	GEBLÄSEKUPPLUNG MIT VENTILATOR	
210	560700 21100	LÜFTERHAUBE KOMPLETT	
282	736001 99624	VAKUUMREGULIERVENTIL	
288	948066 00000	DICHRING	
293	727510 99323	ABBLASEVENTIL	



LAGERFETT 960000 02300 AMBLYGON TA15/2 (TUBE, 8g)

¹⁾ Dichtungssatz - 54900021100 - Pos.: 20, 24, 62, 75, 76, 104, 125, 126, 127, 146, 288
²⁾ erforderliche Bestellmenge / Wartung

OPTIONAL

KVT 3.80	USA	alle Ausführungen
	/0-54	Sonderausführung - Abluft-Umleitung
	/6	Sonderausführung - Korrosionsschutz
	/6-60	Sonderausführung - Korrosionsschutz / ohne C-Abscheider
	/6-66	Sonderausführung - Korrosionsschutz
	/6-67	Sonderausführung - Korrosionsschutz

Abweichende Positionen zum Standardgerät - siehe Anhang (Zeichnungsrückseite)





KVT 3.80

Pos.	Ident No.	Description
...	549000 21100	SET OF SEALS ¹⁾
6	000100 21100	PUMP BODY
9	020004 21100	ROTOR
11	901330 00004	CARBON VANES (KIT) ²⁾
15	000801 21100	LID
16	000701 21100	LID
18	001100 21100	BEARING COVER
19	001000 21100	BEARING COVER
20	025511 21100	GASKET
24	911312 00000	SEAL
26	917152 00000	COMPENSATING DISC
27	906540 00000	SHAFT-SEALING RING
28	906612 50000	BALL BEARING
29	906657 00000	BALL BEARING
31	511400 10100	SET DISTANCE DISC
37	945217 00000	HEX HEAD SCREW
38	016801 21100	CLAMPING DISC
39	949807 00000	SCREW
41	945224 00000	HEX-HEAD SCREW
42	945222 00000	HEX-HEAD SCREW
45	948742 00000	STRAIGHT PIN
47	947736 00000	KEY
50	053201 21100	CONNECTION FLANGE
52	950308 00000	WASHER
53	945337 00000	SOCKET HEAD SCREW
57	949409 00000	WASHER
58	945270 00000	SHAFT END BOLD
61	040101 21100	FILTER HOUSING
62	025501 21100	GASKET
64	946955 00000	STUD
65	951003 00000	STUD
67	964407 00000	SILENCER TUBE
68	909507 00000	FILTER CARTRIDGE C 1112/2 (1x) ²⁾
71	009000 27000	LEAF SPRING
73	040201 21100	FILTER-COVER
75	025518 21100	GASKET
76	025516 21100	GASKET
77	022802 21100	FILTER HOLDER
79	945320 00000	SOCKET HEAD SCREW
81	947504 00000	WASHER
83	952019 00000	LOCATING PEG
91	909510 00000	FILTER CARTRIDGE C 713 (1x) ²⁾
93	946965 00000	STUD
94	947105 00000	HEX.NUT
95	949450 00000	WASHER
97	950304 00000	WASHER
98	945322 00000	SOCKET HEAD SCREW
103	068801 21100	COVER
104	025513 21100	GASKET
105	945319 00000	SOCKET HEAD SCREW
106	950304 00000	WASHER
110	921500 50000	HANDLE
121	560204 21100	COOLER
125	025504 21100	GASKET
126	025512 21100	GASKET
127	025517 21100	GASKET
129	945372 00000	SOCKET HEAD SCREW
130	945328 00000	SOCKET HEAD SCREW
131	945320 00000	SOCKET HEAD SCREW
132	946930 00000	STUD



KVT 3.80

Pos.	Ident No.	Description
134	005602 21100	COVER
142	016605 21100	CONNECTING PIECE
146	025507 21100	GASKET
148	945368 00000	SOCKET HEAD SCREW
149	741310 30000	RUBBER BUFFER
150	950304 00000	WASHER
161	918300 21100	COVERING HOOD
163	920800 21100	AIR GUIDE HOOD
165	960700 21100	VENTILATOR HOOD
170	945321 00000	SOCKET HEAD SCREW
171	945371 00000	SOCKET HEAD SCREW
172	945319 00000	SOCKET HEAD SCREW
173	949806 00000	SCREW
174	951703 00000	SPRING DISC
175	741302 00000	RUBBER BUFFER
176	945634 00000	THREADED PIN
178	951602 00000	RING UNIT
182	014902 21100	FLANGES
184	951916 00000	RUBBER BUSHING
185	948772 00000	PIPE RIVET
186	947508 00000	WASHER
188	945333 00000	SOCKET HEAD SCREW
189	950308 00000	WASHER
190	951018 00000	STUD
191	947506 00000	WASHER
192	947106 00000	HEX.NUT
195	902108 00000	COUPLING
196	902209 00000	COUPLING DISC
197	544501 21100	COUPLING WITH FAN
210	560700 21100	VENTILATOR HOOD, COMPL.
282	736001 99624	VACUUM REGULATING VALVE
288	948066 00000	SEALING RING
293	727510 99323	BLOW-OFF VALVE



GREASE 960000 02300 AMBLYGON TA15/2 (TUBE, 8g)

¹⁾ Set of seals - 54900021100 - Pos.: 20, 24, 62, 75, 76, 104, 125, 126, 127, 146, 288
²⁾ necessary order quantity / maintenance

OPTIONAL

KVT 3.80	USA	all types
	/0-54	Special design - exhaust air rear guide
	/6	Special design - corrosion protection
	/6-60	Special design - corrosion protection / without C-separator
	/6-66	Special design - corrosion protection
	/6-67	Special design - corrosion protection

Items different from standard appliance see appendix (back of drawing) 



KVT 3.80

Pos.	No. Identification	Designation
...	549000 21100	JEU DE JOINTS ¹⁾
6	000100 21100	CORP DE POMPE
9	020004 21100	PISTON
11	901330 00004	PALETTE DE CHARBON (KIT) ²⁾
15	000801 21100	COUVERCLE
16	000701 21100	COUVERCLE
18	001100 21100	COUVERCLE DE ROULEMENT
19	001000 21100	COUVERCLE DE ROULEMENT
20	025511 21100	JOINT
24	911312 00000	JOINT
26	917152 00000	DISQUE DE COMPENSATION
27	906540 00000	BAGUE D'ETANCHEITE P.L'AXE
28	906612 50000	ROULEMENT A BILLES
29	906657 00000	ROULEMENT A BILLES
31	511400 10100	JEU DISQUE DE TOLERANCE
37	945217 00000	VIS HEXAGONALE
38	016801 21100	DISQUE DE SERRAGE
39	949807 00000	VIS
41	945224 00000	VIS HEXAGONALE
42	945222 00000	VIS HEXAGONALE
45	948742 00000	GOUPILLE CYLINDRIQUE
47	947736 00000	CLAVETTE
50	053201 21100	BRIDE DE RACCORDEMENT
52	950308 00000	RONDELLE
53	945337 00000	VIS HEXAGONALE INTERNE
57	949409 00000	RONDELLE
58	945270 00000	VIS BOUT D'ARBRE
61	040101 21100	BOITE POUR FILTRE
62	025501 21100	JOINT
64	946955 00000	TOURILLON
65	951003 00000	TOURILLON
67	964407 00000	TUBE SILENCIEUX
68	909507 00000	CARTOUCHE FILTRANTE C 1112/2 (1x) ²⁾
71	009000 27000	RESSORT-JAME
73	040201 21100	COUVERCLE DU FILTRE
75	025518 21100	JOINT
76	025516 21100	JOINT
77	022802 21100	SUPPORT FILTRE
79	945320 00000	VIS HEXAGONALE INTERNE
81	947504 00000	RONDELLE
83	952019 00000	DOUILLE DE ETRAGE
91	909510 00000	CARTOUCHE FILTRANTE C 713 (1x) ²⁾
93	946965 00000	PRISONNIER
94	947105 00000	ECROU A 6 PANS
95	949450 00000	RONDELLE
97	950304 00000	RONDELLE
98	945322 00000	VIS HEXAGONALE INTERNE
103	068801 21100	COUVERCLE
104	025513 21100	JOINT
105	945319 00000	VIS HEXAGONALE INTERNE
106	950304 00000	RONDELLE
110	921500 50000	POIGNEE
121	560204 21100	REFROIDISSEUR
125	025504 21100	JOINT
126	025512 21100	JOINT
127	025517 21100	JOINT
129	945372 00000	VIS HEXAGONALE INTERNE
130	945328 00000	VIS HEXAGONALE INTERNE
131	945320 00000	VIS HEXAGONALE INTERNE
132	946930 00000	PRISONNIER



KVT 3.80

Pos.	No. Identification	Designation
134	005602 21100	COUVERCLE
142	016605 21100	PIECE RACCORD
146	025507 21100	JOINT
148	945368 00000	VIS HEXAGONALE INTERNE
149	741310 30000	AMORTISSEUR EN CAOUTCHOUC
150	950304 00000	RONDELLE
161	918300 21100	CARTER
163	920800 21100	CAPOT DE CANALISATION DE L'AIR
165	960700 21100	CARTER DE VENTILATEUR
170	945321 00000	VIS HEXAGONALE INTERNE
171	945371 00000	VIS HEXAGONALE INTERNE
172	945319 00000	VIS HEXAGONALE INTERNE
173	949806 00000	VIS À TÊTE NOYÉE
174	951703 00000	DISQUE DE RESSORT
175	741302 00000	AMORTISSEUR EN CAOUTCHOUC
176	945634 00000	GOUPILLE FILETEE
178	951602 00000	ECROU A ANNEAU
182	014902 21100	BRIDES
184	951916 00000	PROTECTION EN CAOUTCHOUC
185	948772 00000	RIVET TUBE
186	947508 00000	RONDELLE
188	945333 00000	VIS HEXAGONALE INTERNE
189	950308 00000	RONDELLE
190	951018 00000	PRISONNIER
191	947506 00000	RONDELLE
192	947106 00000	ECROU A 6 PANS
195	902108 00000	ACCOUPLLEMENT
196	902209 00000	DISQUE D'ACCOUPLLEMENT
197	544501 21100	ACCOUPLLEMENT AVEC VENTILATEUR
210	560700 21100	CARTER DE VENTILATEUR, COMPL.
282	736001 99624	SOUPAPE REGULAGE VIDE
288	948066 00000	JOINT
293	727510 99323	SILENCIEUX



GRAISSE 960000 02300 AMBLYGON TA15/2 (TUBE, 8g)

¹⁾ Jeu de joints - 54900021100 - Pos.: 20, 24, 62, 75, 76, 104, 125, 126, 127, 146, 288
²⁾ quantité nécessaire / entretien

EN OPTION

KVT 3.80	USA	Tous les fabrication
	/0-54	Fabrication spéciale – guide de derrière / air évacué
	/6	Fabrication spéciale – protection contre la corrosion
	/6-60	Fabrication spéciale – protection contre la corrosion / sans filtre séparateur de carbone
	/6-66	Fabrication spéciale – protection contre la corrosion
	/6-67	Fabrication spéciale – protection contre la corrosion

Articles divergents vis-à-vis de l'appareil standard, voir annexe (dos du dessin / du plan)



KVT 3.80

Pos.	No. Identificazione	Designazione
...	549000 21100	SERIE DI GUARNIZIONE ¹⁾
6	000100 21100	CARCASSA
9	020004 21100	ROTORE
11	901330 00004	PALETTE DI CHARBONE (KIT) ²⁾
15	000801 21100	COPERCHIO
16	000701 21100	COPERCHIO
18	001100 21100	COPERCHIO CUSCINETTO
19	001000 21100	COPERCHIO CUSCINETTO
20	025511 21100	GUARNIZIONE
24	911312 00000	GUARNIZIONE
26	917152 00000	DISCO COMPENSATORE
27	906540 00000	GUARNIZIONE PER L'ALBERO
28	906612 50000	CUSCINETTO A SFERA
29	906657 00000	CUSCINETTO A SFERA
31	511400 10100	SERIE DISCO GIUOCO
37	945217 00000	VITE ESAGONALE
38	016801 21100	DISCO DI FISSAGGIO
39	949807 00000	VITE
41	945224 00000	VITE ESAGONALE
42	945222 00000	VITE ESAGONALE
45	948742 00000	PERNO
47	947736 00000	CHIAVETTA
50	053201 21100	FLANGIA DI RACCORDE
52	950308 00000	RONDELLA
53	945337 00000	VITE ESAGONALE INTERNA
57	949409 00000	RONDELLA
58	945270 00000	VITE DI CHIUSURA ALBERO
61	040101 21100	CONTENITORE FILTRO A CARTUCCIA
62	025501 21100	GUARNIZIONE
64	946955 00000	PRIGIONIERO
65	951003 00000	L'ASTA A VITE
67	964407 00000	TUBO SILENZIATORE
68	909507 00000	CARTUCCIA FILTRO C 1112/2 (1x) ²⁾
71	009000 27000	MOLLA
73	040201 21100	COPERCHIO FILTRO
75	025518 21100	GUARNIZIONI
76	025516 21100	GUARNIZIONE
77	022802 21100	SUPPORTO FILTRO
79	945320 00000	VITE ESAGONALE INTERNA
81	947504 00000	RONDELLA
83	952019 00000	SPINE DI RISCANTRO
91	909510 00000	CARTUCCIA FILTRO C 713 (1x) ²⁾
93	946965 00000	L'ASTA A VITE
94	947105 00000	DADO ESAGONALE
95	949450 00000	RONDELLA
97	950304 00000	RONDELLA
98	945322 00000	VITE ESAGONALE INTERNA
103	068801 21100	COPERCHIO
104	025513 21100	GUARNIZIONE
105	945319 00000	VITE ESAGONALE INTERNA
106	950304 00000	RONDELLA
110	921500 50000	MANETTA
121	560204 21100	RAFFREDDATORE
125	025504 21100	GUARNIZIONE
126	025512 21100	GUARNIZIONE
127	025517 21100	GUARNIZIONI
129	945372 00000	VITE ESAGONALE INTERNA
130	945328 00000	VITE ESAGONALE INTERNA
131	945320 00000	VITE ESAGONALE INTERNA
132	946930 00000	L'ASTA A VITE



KVT 3.80

Pos.	No. Identificazione	Designazione
134	005602 21100	COPERCHIO
142	016605 21100	PEZZI RACCORDI
146	025507 21100	GUARNIZIONE
148	945368 00000	VITE ESAGONALE INTERNA
149	741310 30000	AMMORTIZZATORE IN GOMMA
150	950304 00000	RONDELLA
161	918300 21100	CARTER
163	920800 21100	CAPPOTTA DEL CONDOTTA ARIA
165	960700 21100	CARTER DEL VENTILATORE
170	945321 00000	VITE ESAGONALE INTERNA
171	945371 00000	VITE ESAGONALE INTERNA
172	945319 00000	VITE ESAGONALE INTERNA
173	949806 00000	VITE A TESTA SVASATA
174	951703 00000	DISCO A MOLLA
175	741302 00000	AMMORTIZZATORE IN GOMMA
176	945634 00000	SPINA FILETTATURA
178	951602 00000	GOLFARE CON FORO FILETTATO
182	014902 21100	FLANGE
184	951916 00000	PROTEZIONE IN GOMMA
185	948772 00000	CHIODO TUBOLARE
186	947508 00000	RONDELLA
188	945333 00000	VITE ESAGONALE INTERNA
189	950308 00000	RONDELLA
190	951018 00000	L'ASTA A VITE
191	947506 00000	RONDELLA
192	947106 00000	DADO ESAGONALE
195	902108 00000	GIUNTO
196	902209 00000	DISCO GIUNTO
197	544501 21100	GIUNTO CON VENTILATORE
210	560700 21100	CARTER DEL VENTILATORE, COMPL.
282	736001 99624	VALVOLA REGOLAZIONE VUOTO
288	948066 00000	ANELLO GUARNIZIONE
293	727510 99323	SILENZIATORE



GRASSO 960000 02300 AMBLYGON TA15/2 (TUBETTO, 8g)

¹⁾ Serie di guarnizione - 54900021100 - Pos.: 20, 24, 62, 75, 76, 104, 125, 126, 127, 146, 288
²⁾ quantità di ordinazione necessari / manutenzione

OPZIONALE

KVT 3.80	USA	Tutte tipi
	/0-54	Modello speciale - guida di vitorno / aria estratta
	/6	Modello speciale - protezione anti-corrosione
	/6-60	Modello speciale - protezione anti-corrosione / senza filtro separatore de carbonio
	/6-66	Modello speciale - protezione anti-corrosione
	/6-67	Modello speciale - protezione anti-corrosione

Vedere allegato (retro del disegno) per le posizioni divergenti dall'apparecchio standard





KVT 3.80

Pos.	No. De pedido	Descripción	
...	549000 21100	JUEGO DE JUNTA ¹⁾	
6	000100 21100	CARCASA	
9	020004 21100	ÉMBOLO	
11	901330 00004	EMPUJADOR (KIT) ²⁾	
15	000801 21100	TAPA LATERAL	
16	000701 21100	TAPA LATERAL	
18	001100 21100	TAPA DE COJINETE LADO A	
19	001000 21100	TAPA DE COJINETE LADO B	
20	025511 21100	JUNTA	
24	911312 00000	MANGUERA DE JUNTA	
26	917152 00000	ARANDELA DE COMPENSACIÓN	
27	906540 00000	ANILLO DE JUNTA DE ÁRBOL	
28	906612 50000	COJINETE DE RODAMIENTO 3205 2RS C3 TA	
29	906657 00000	COJINETE DE RODAMIENTO NU 205/ZS	
31	511400 10100	JUEGO DE ARANDELAS DISTANCIADORAS	
37	945217 00000	TORNILLO DE CABEZA HEXAGONAL	
38	016801 21100	ARANDELA TENSORA	
39	949807 00000	TORNILLO AVELLANADO	
41	945224 00000	TORNILLO DE CABEZA HEXAGONAL	
42	945222 00000	TORNILLO DE CABEZA HEXAGONAL	
45	948742 00000	PASADOR ENTALLADO DE AJUSTE	
47	947736 00000	LENGÜETA DE AJUSTE	
50	053201 21100	FAROL	
52	950308 00000	ARANDELA	
53	945337 00000	TORNILLO HEXAGONAL INTERIOR	
57	949409 00000	ARANDELA	
58	945270 00000	TORNILLO TERMINAL DE ÁRBOL	
61	040101 21100	CARCASA DE FILTRO	
62	025501 21100	JUNTA	
64	946955 00000	ESPÁRRAGO	
65	951003 00000	ESPÁRRAGO	
67	964407 00000	TUBO DE SILENCIADOR	
68	909507 00000	CARTUCHO DE FILTRO C 1112/2 (1x) ²⁾	
71	009000 27000	MUELLE DE PRESIÓN	
73	040201 21100	TAPA DE FILTRO	
75	025518 21100	JUNTA	
76	025516 21100	JUNTA	
77	022802 21100	SOPORTE DE FILTRO	
79	945320 00000	TORNILLO HEXAGONAL INTERIOR	
81	947504 00000	ARANDELA	
83	952019 00000	CASQUILLO TENSOR	
91	909510 00000	CARTUCHO DE FILTRO C 713 (1x) ²⁾	
93	946965 00000	ESPÁRRAGO	
94	947105 00000	TUERCA HEXAGONAL	
95	949450 00000	ARANDELA	
97	950304 00000	ARANDELA	
98	945322 00000	TORNILLO HEXAGONAL INTERIOR	
103	068801 21100	TAPA	
104	025513 21100	JUNTA	
105	945319 00000	TORNILLO HEXAGONAL INTERIOR	
106	950304 00000	ARANDELA	
110	921500 50000	EMPUÑADURA	
121	560204 21100	REFRIGERADOR	
125	025504 21100	JUNTA	
126	025512 21100	JUNTA	
127	025517 21100	JUNTA	
129	945372 00000	TORNILLO HEXAGONAL INTERIOR	
130	945328 00000	TORNILLO HEXAGONAL INTERIOR	
131	945320 00000	TORNILLO HEXAGONAL INTERIOR	
132	946930 00000	ESPÁRRAGO	



KVT 3.80

Pos.	No. De pedido	Descripción	
134	005602 21100	TAPA	
142	016605 21100	PIEZA DE EMPALME	
146	025507 21100	JUNTA	
148	945368 00000	TORNILLO HEXAGONAL INTERIOR	
149	741310 30000	AMORTIGUADOR DE GOMA	
150	950304 00000	ARANDELA	
161	918300 21100	CAPERUZA DE RECUBRIMIENTO	
163	920800 21100	CAPERUZA CONDUCTOR DE AIRE	
165	960700 21100	CAPERUZA DE VENTILADOR	
170	945321 00000	TORNILLO HEXAGONAL INTERIOR	
171	945371 00000	TORNILLO HEXAGONAL INTERIOR	
172	945319 00000	TORNILLO HEXAGONAL INTERIOR	
173	949806 00000	TORNILLO AVELLANADO	
174	951703 00000	ARANDELA ELÁSTICA	
175	741302 00000	AMORTIGUADOR DE GOMA	
176	945634 00000	VARILLA ROSCADA	
178	951602 00000	TUERCA DE CÁNCAMO	
182	014902 21100	BRIDA INTERMEDIA	
184	951916 00000	BOQUILLA DE CABLE	
185	948772 00000	REMACHE TUBULAR	
186	947508 00000	ARANDELA	
188	945333 00000	TORNILLO HEXAGONAL INTERIOR	
189	950308 00000	ARANDELA	
190	951018 00000	ESPÁRRAGO	
191	947506 00000	ARANDELA	
192	947106 00000	TUERCA HEXAGONAL	
195	902108 00000	MITAD DE ACOPLAMIENTO (MOT)	
196	902209 00000	DISCO DE ACOPLAMIENTO	
197	544501 21100	ACOPLAMIENTO DE SOPLADO CON VÁLVULA	
210	560700 21100	CAPERUZA DE VENTILADOR COMPLETA	
282	736001 99624	VÁLVULA REGULADORA DE VACÍO	
288	948066 00000	ANILLO DE JUNTA	
293	727510 99323	VÁLVULA DE BARRIDO	



GRASA 960000 02300 AMBLYGON TA15/2 (TUBO, 8g)

¹⁾ Junta completa - 54900021100 - Pos.: 20, 24, 62, 75, 76, 104, 125, 126, 127, 146, 288

²⁾ cantidad necesario / mantenimiento

OPCIONAL

KVT 3.80	USA	Versión general
	/0-54	Versión especial – guía posterior / aire de extraccion
	/6	Versión especial – protección contra la corrosión
	/6-60	Versión especial – protección contra la corrosión / sin filtro separador de carbono
	/6-66	Versión especial – protección contra la corrosión
	/6-67	Versión especial – protección contra la corrosión

Para posiciones que derivan del aparato standard véase apéndice (lado trasero del plano)

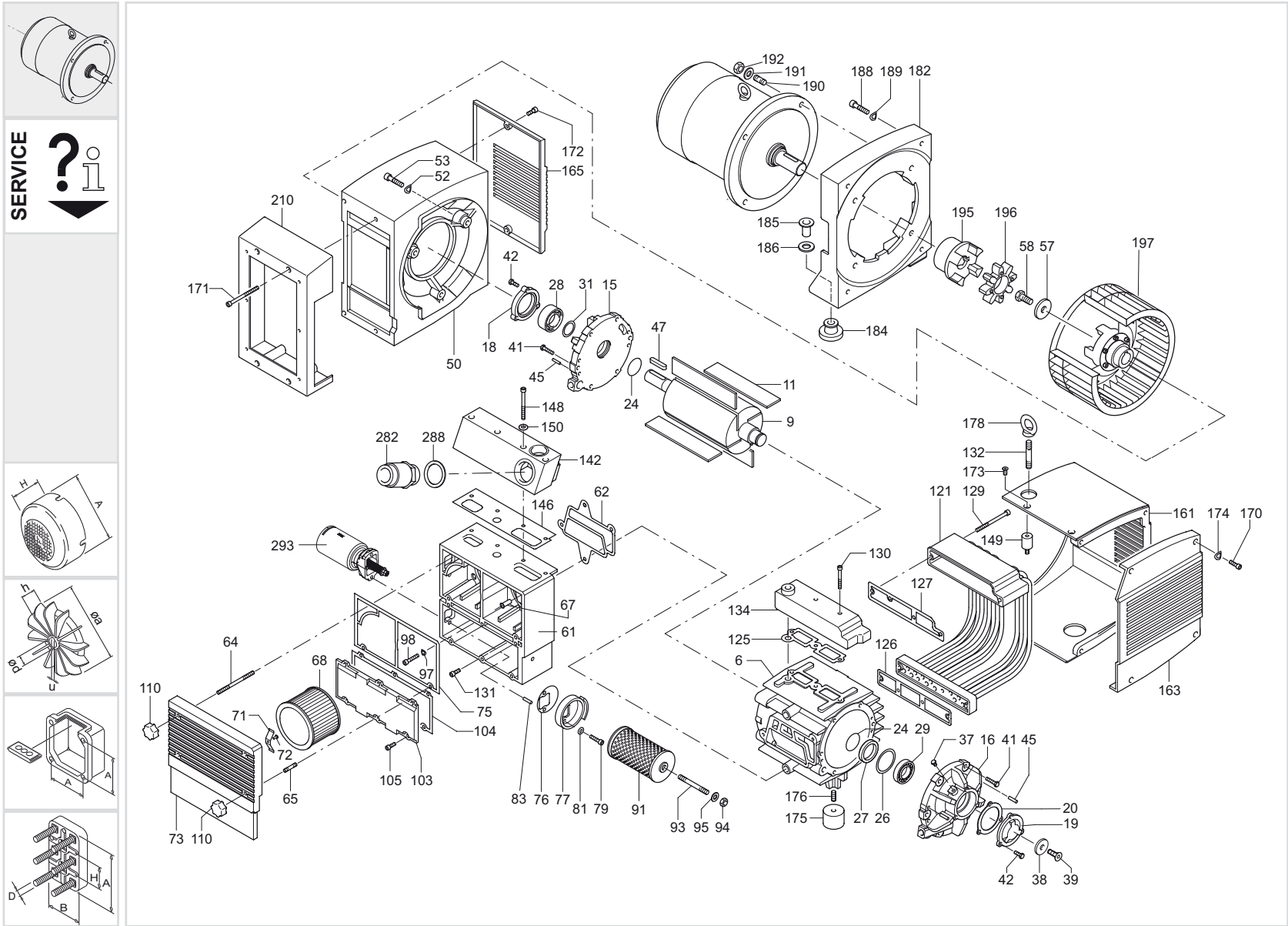









SERVICE ?

standard

KVT 3.80

optional
en option
opcionale
opcional

optional en option optionale opcional 	Variante(n) Modifications Variantes	Pos ³⁾	Bestell Nr. / Ident No. / No. Identification / No. Identificazione / No. De pedido		Beschreibung / Description / Designation / Designazione / Descripcion
					
KVT 3.80/XX	KVT 3.80 (USA)	190 191 192 195	902100 21100	951018-00000 947506-00000 947106-00000 902108-00000	STIFTSCHRAUBE / STUD / TOURILLON / L'ASTA A VITE / ESPÁRRAGO UNTERLEGSSCHEIBE / WASHER / RONDELLE / RONDELLA / ARANDELA SECHSKANTMUTTER / HEX.NUT / ECROU A 6 PANS / DADO ESAGONALE / TUERCA HEXAGONAL MOTORKUPPLUNG / COUPLING / ACCOUPLEMENT / GIUNTO / ACOPLAMIENTO
	KVT 3.80/0-54	80 82 86 141 142 230 293	946944 00000 947104 00000 025515 21100 016606 21100 019901 21100	016605-21100 727510-99323	STIFTSCHRAUBE / STUD / TOURILLON / L'ASTA A VITE / ESPÁRRAGO SECHSKANTMUTTER / HEX.NUT / ECROU A 6 PANS / DADO ESAGONALE / TUERCA HEXAGONAL DICHTUNG / GASKET / JOINT / GUARNIZIONE / JUNTA ANSCHLUSS-STÜCK / CONNECTING PIECE / PIECE RACCORD / PEZZI RACCORDI / PIEZA DE EMPALME ANSCHLUSS-STÜCK / CONNECTING PIECE / PIECE RACCORD / PEZZI RACCORDI / PIEZA DE EMPALME UMLENKSTÜCK / RETURN PIECE / PIECE DE RETOUR / PEZZO INVERSIONE / PIEZA DE DESVIACIÓN ABBLASEVENTIL / BLOW-OFF VALVE / SOUPAPE D'ECHAPPEMENT / VALVOLA DI SFIATO / VALVULA DE ESCAPE
	KVT 3.80/6	6 9 11 15 16 68	000110 21100 020011 21100 901379 00004 000811 21100 000711 21100 909587 00000	000100-21100 020004-21100 901330-00004 000801-21100 000701-21100 909507-00000	GEHÄUSE / PUMP BODY / CORP DE POMPE / CARCASSA / CARCASA KOLBEN / ROTOR / PISTON / ROTORE / ÉMBOLO (SATZ / KIT) SCHIEBER / VANES / PALETTE / PALETTE / EMPUJADOR SEITENDECKEL / LID / COUVERCLE / COPERCHIO / TAPA LATERAL SEITENDECKEL / LID / COUVERCLE / COPERCHIO / TAPA LATERAL FILTERPATRONE / FILTER CARTRIDGE / CARTOUCHE FILTRANTE / CARTUCCIA FILTRO / CARTUCHO DE FILTRO
	  KVT 3.80/6-60	76 77 91 93 94 95	946108 00000	025516-21100 022802-21100 909510-00000 946965-00000 947105-00000 949450-00000	DICHTUNG / GASKET / JOINT / GUARNIZIONE / JUNTA FILTERTRÄGER / FILTER HOLDER / SUPPORT FILTRE / SUPPORTO FILTRO / SOPORTE DE FILTRO FILTERPATRONE / FILTER CARTRIDGE / CARTOUCHE FILTRANTE / CARTUCCIA FILTRO / CARTUCHO DE FILTRO GEWINDESTIFT / THREADED PIN / GOUPILLE FILETEE / SPINA FILETTATURA / VARILLA ROSCADA SECHSKANTMUTTER / HEX.NUT / ECROU A 6 PANS / DADO ESAGONALE / TUERCA HEXAGONAL UNTERLEGSSCHEIBE / WASHER / RONDELLE / RONDELLA / ARANDELA
	  KVT 3.80/6-66   KVT 3.80/6-67	61 77 91 (6-67) - 175 (6-67) - 190 (6-67) - 195	040104 21100 068000 21100 951024 00000	040101-21100 022802-21100 909510-00000 741302-00000 951018-00000 902108-00000	FILTERGEHÄUSE / FILTER HOUSING / BOITE POUR FILTRE / CONTENITORE FILTRO A CARTUCCIA / CARCASA DE FILTRO FILTERTRÄGER / FILTER HOLDER / SUPPORT FILTRE / SUPPORTO FILTRO / SOPORTE DE FILTRO FILTERPATRONE / FILTER CARTRIDGE / CARTOUCHE FILTRANTE / CARTUCCIA FILTRO / CARTUCHO DE FILTRO Distanzstück / INTERMEDIATE PIECE / PIECE D'ECARTEMENT / PEZZO DI SCOSTAMENTO / PIEZA DISTANCIADORA STIFTSCHRAUBE / STUD / TOURILLON / L'ASTA A VITE / ESPÁRRAGO MOTORKUPPLUNG / COUPLING / ACCOUPLEMENT / GIUNTO / ACOPLAMIENTO

³⁾ variantenabhängige Bauteile / variant-dependent components / composants variante-dependantes / componenti variante-dispendenti / componentes variante-dependientes